

Series Features:

- Quality assured manufacturer in Turkey
- Robust and reliable rack and pinion design
- Available as Double Acting or Single Acting (Failsafe)
- ISO5211 compliant and Namur VDI-VDE3845
- Pre-compressed spring cartridges for Single Acting version
- External end of travel adjustment available
- ATEX complaint and CE certified
- Option of high and low temperature versions
- Optional body coating for corrosive applications
- Large stock held in UK for next day delivery
- Double Acting 9Nm to 9767Nm and Single Acting 9Nm to 3866Nm



Main Specifications:	
Feature:	Detail:
Enclosure	Powder coated aluminium
Pinion	Alloy steel
Position Indicator	Plastic
End Cap	Die-cast aluminium
Piston	Die-cast aluminium
O Ring	NBR

Brand:

AVP

AVP pneumatic actuators are of the time proven rack and pinion design and with a hard anodised aluminium body, producing a rugged and reliable compressed air driven part turn valve actuator. Valve torques up to 13,000Nm are covered by 18 double acting AVP models and torques up to 4,100Nm by 16 single acting, spring return AVP models.

Options:	
Device	Description
Namur Solenoid	24VAC, 24VDC, 110VAC or 230VAC 5/2 or 3/2 solenoid
Limit Switchbox	2 x V3 Mechanical Switchbox for position feedback
Positioner	4-20mA Electro Pneumatic Positioner
Stainless Enclosure	Stainless steel enclosure available
Speed Controller	Namur Speed Controller for closing speed
Extended Travel	Extended screws available for 0-180 movement
ATEX Accessories	Full range of ATEX accessories
High / Low Temp	Special greases and seals for high/low temperatures

Approvals include:



Note:

- 1) The rotation can be reversed so that the AVP actuator opens clockwise and closes counter clockwise.
- 2) All valves size air actuated valve assemblies using 6 bar air supply at the actuator.



Materials of Construction:

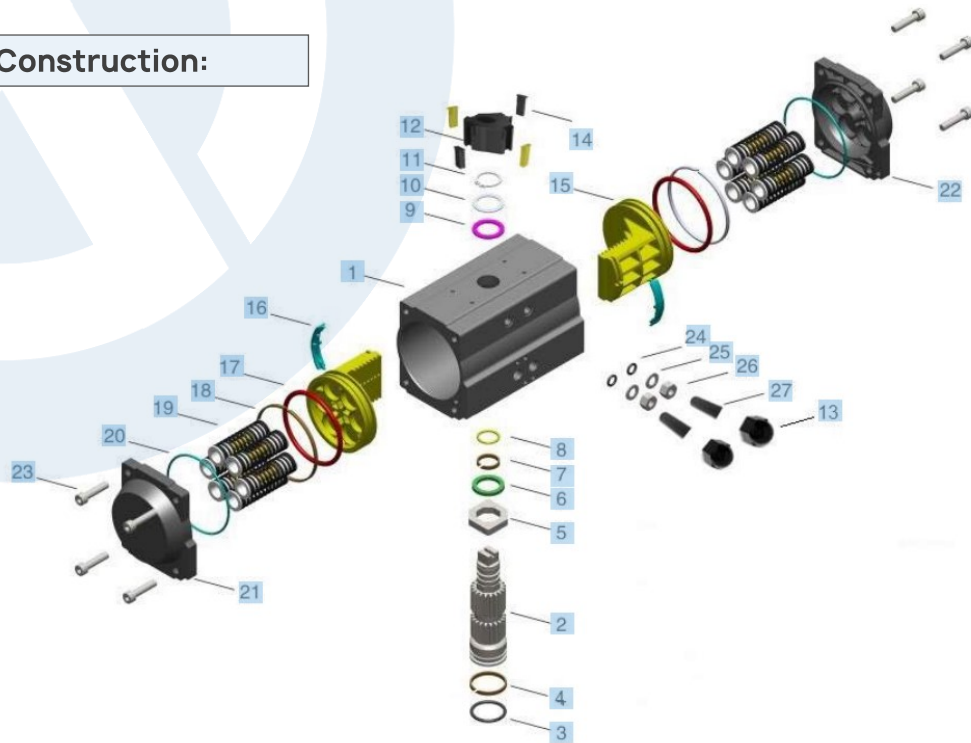

Part	Description	Qty	Standard Material	Standard Protection	Optional Material/ protection
1	Body	1	Extruded aluminium alloy	Hard anodising	Stainless steel, Epoxy/ nickel coating
2	Pinion	1	Alloy steel	Nickel plating	Galvanised coating, stainless steel
3	Pinion lower O ring	1	NBR		
4	Pinion lower bearing	1	Engineered plastics		
5	Cam	1	Alloy steel		
6	Pinion upper bearing	1	Engineered plastics		
7	Pinion upper O ring	1	NBR		
8 & 9	Washer	1	Engineered plastics		
10	Washer	1	Stainless steel		
11	Circlip	1	Stainless steel		
12-14	Position indicator	1	Plastic		
15	Piston	2	Die-cast aluminium	Alodine coated	
16	Piston guide slide	2	Engineered plastics		
17	Piston bearing	2	Engineered plastics		
18	Piston O ring	2	NBR		
19	Spring cartridge assembly	4-12	Spring steel	Cataphoresis coated	
20	End cap O ring	2	NBR		
21-22	End cap	2	Die cast aluminium	Epoxy powder coated	
23	Fixing screws	8	Stainless steel		
24-27	Adjusting screw assembly	2	Stainless steel		



Dimensions:

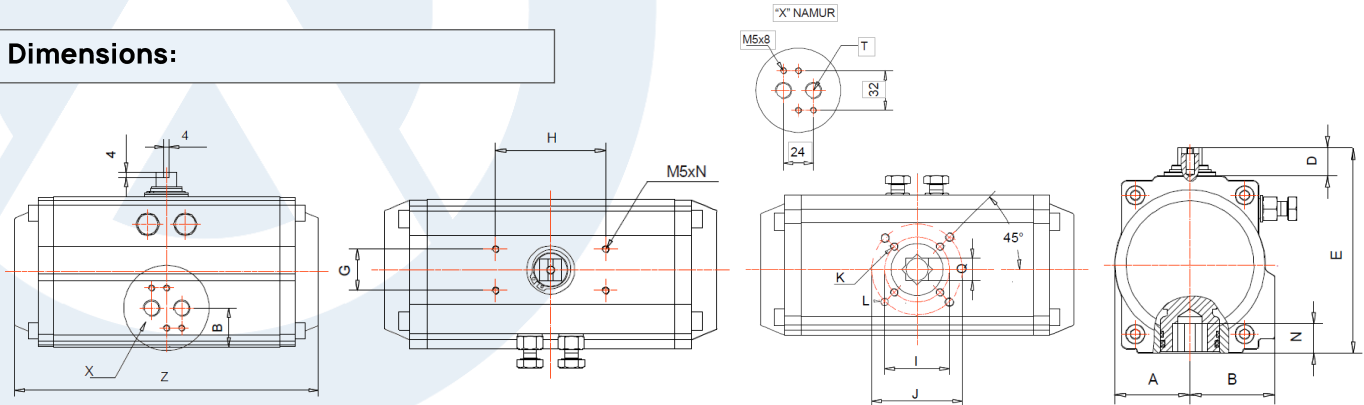

MODEL	A	B	D	E	G	H	ØI	ØJ	K	L	M	N	Z	T	Kg (DA)	Kg (SR)
AVP-32	23	23	20	65	25	50	36	-	M5x8	-	9	14	99	1/8"	0.5	-
AVP-40	40	36	20	81	30	80	36	50	M5x8	M6x10	11	14	124	1/4"	0.7	-
AVP-52	30	40	20	92	30	80	36	50	M5x8	M6x10	11	14	154	1/4"	1.4	1.5
AVP-63	36	47	20	108	30	80	50	70	M6x10	M8x13	14	18	166	1/4"	2.1	2.2
AVP-75	42	53	20	120	30	80	50	70	M6x10	M8x13	14	18	186	1/4"	2.7	2.9
AVP-83	46	57	20	129	30	80	50	70	M6x10	M8x13	17	21	205	1/4"	3.3	3.6
AVP-92	50	58	20	137	30	80	50	70	M6x10	M8x13	17	21	253	1/4"	5.0	5.5
AVP-105	58	64	20	153	30	80	70	102	M8x13	M10x16	22	26	238	1/4"	5.9	6.7
AVP-125	68	75	20	175	30	80	70	102	M8x13	M10x16	22	26	301	1/4"	9.0	10.4
AVP-140	75	77	20	192	30	80	102	125	M10x16	M12x20	27	31	392	1/4"	12.0	14.4
AVP-160	87	87	20	217	30	80	102	125	M10x16	M12x20	27	31	451	1/4"	19.0	23.3
AVP-190	103	103	30	260	30	130		140		M16x25	36	40	525	1/4"	39.1	46.1
AVP-210	113	113	30	285	30	130		140		M16x25	36	40	532	1/4"	44.1	53.1
AVP-240	130	130	30	318	30	130		165		M20x25	46	50	610	1/4"	59.0	73.3
AVP-270	147	147	30	356	30	130		165		M20x25	46	50	722	1/4"	93.6	115.9
AVP-300	140	173	30	382	30	130		165		M20x25	46	55	774	1/2"	130	110
AVP-350	164	195	30	438	30	130	165	254	M20x25	M16x25	46	50	912	1/2"	235	187
AVP-400	260	260	30	494	30	130	165	254	M20x25	M16x25	46	50	945	1/2"	361	289

Air Consumption (L/Stroke)

MODEL	32	40	52	63	75	83	92	105	125	140	160	190	210	240	270	300	350	400
Opening	0.03	0.06	0.12	0.21	0.30	0.43	0.64	0.88	1.4	2.2	3.2	5.4	6.8	9	14	23.8	35.1	52.6
52.6Closing	0.04	0.08	0.16	0.23	0.34	0.47	0.73	0.95	1.6	2.5	3.7	5.9	7.5	11	17	29.7	46.3	36



Torque Output - Double Acting

AVP double acting pneumatic actuators require compressed air to be supplied in both the opening and closing strokes.

The torque output in double acting AVP actuators varies depending on the piston diameter and the air pressure (force = pressure x area). As shown in the diagram to the right the torque output of AVP double acting pneumatic actuators is constant throughout the full 90° stroke.

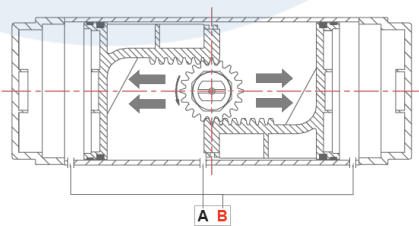
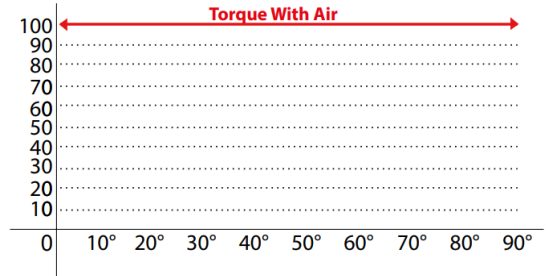

Standard function:
Closes clockwise

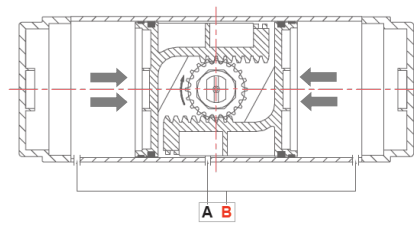

Air supplied through port A forces the pistons apart rotating the output shaft counter clockwise and opens the actuator

Air supplied through port B forces the pistons together rotating the output shaft clockwise and closes the actuator

MODEL	Air Supply Pressure (bar)									
	2.0	2.5	3.0	4.0	4.5	5.0	5.5	6.0	7.0	8.0
AVP-32	2	3.5	4	6	7	7.5	8	9	10	12
AVP-40	6	8	10	13	14	16	18	20	22	26
AVP-52	8	10	12	16	18	20	22	24	28	32
AVP-63	15	19	22	30	33	37	40	44	52	58
AVP-75	20	26	30	40	45	50	55	60	70	80
AVP-83	33	40	48	63	71	79	86	94	110	125
AVP-92	45	57	68	90	102	113	124	136	158	182
AVP-105	66	83	100	132	149	166	182	200	232	265
AVP-125	101	126	151	202	226	252	276	301	352	402
AVP-140	171	214	257	342	385	428	471	513	599	684
AVP-160	266	333	399	532	600	665	732	798	932	1064
AVP-190	426	532	639	852	958	1064	1170	1277	1490	1702
AVP-210	532	665	798	1064	1198	1130	1463	1596	1862	2128
AVP-240	770	962	1155	1540	1732	1924	2117	2309	2693	3078
AVP-270	1169	1462	1755	2340	2632	2925	3217	3510	4095	4680
AVP-300	1526	1908	2289	3052	3434	3815	4197	4578	5341	6104
AVP-350	2285	2856	3427	4570	5141	5712	6283	6854	7997	9139
AVP-400	3256	4069	4883	6511	7325	8139	8953	9767	11394	13022

Torque Output - Single Acting

AVP double acting pneumatic actuators require compressed air to be supplied in only the opening stroke as during this stroke, spring cartridges are tensioned and then released to provide the closing stroke.

The torque output in single acting AVP actuators varies depending on the piston diameter, the air pressure and the spring force. Therefore a spring return actuator is larger than a double acting actuator producing the same output torque.

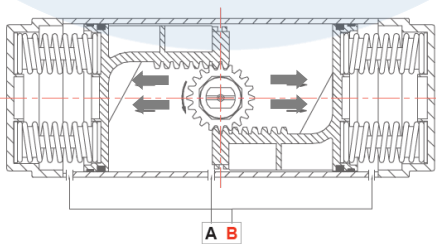
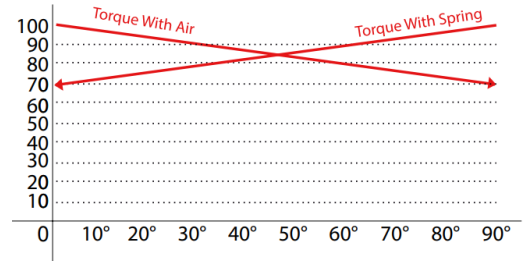

Standard function:
Closes clockwise

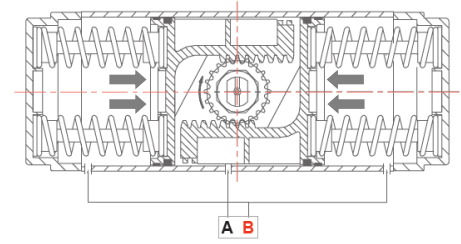

Air supplied through port A forces the pistons apart simultaneously compressing the springs, exhausting air from port B, rotating the output shaft counter clockwise and opening the actuator.

Air holds the actuator open against the compressed springs. When the air is released the springs force the pistons together, exhausting air through port A, rotating the output shaft clockwise and closing the actuator

Pre-compressed Spring Cartridges

Spring return versions of the AVP Pneumatic actuators use pre-compressed spring cartridges to store energy that is released to produce the force to close the actuator when the air pressure is released. The pre-tensioning allows the actuator's end cap to be safely removed. The spring cartridges vary in size depending on the actuator model.

By installing different quantities of springs, the air stroke torques and spring stroke torques can be altered to suit different torque requirements. As standard, AVP spring return actuators are supplied with 12 springs.



Positioning of springs for different torque outputs

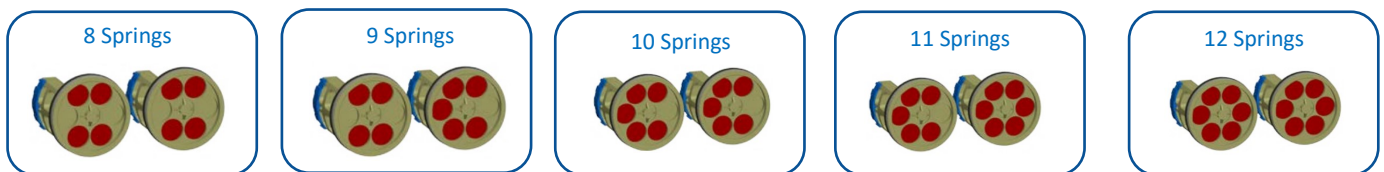

Notes:

- 1) The rotation can be reversed so that the AVP actuator opens clockwise and closes counter clockwise.
- 2) AVOL size air actuated valve assemblies using 6 bar air supply at the actuator.
- 3) The AVP spring return pneumatic actuators are supplied with 6 springs each end as standard.

Torque Output - Single Acting



Highlights best balance between air and spring strokes

Air Supply Pressure		4 Bar		5 Bar		6 Bar		7Bar		Spring Torque	
AVP Model	No of springs	0°	90°	0°	90°	0°	90°	0°	90°	90°	0°
		Air Start	Air End Nm	Air Start Nm	Air End Nm	Air Start Nm	Air End Nm	Air Start Nm	Air End Nm	Spring Start	Spring End Nm
AVP-52SR	8	9.2	6.0	13.2	9.1	17.2	14.1			9.9	6.7
	9	8.3	4.8	12.3	7.9	16.3	12.8	20.3	16.8	11.1	7.6
	10	7.4	3.6	11.5	6.7	15.5	11.6	19.5	15.6	12.4	8.5
	11	6.6	2.3	10.6	5.4	14.6	10.4	18.6	14.3	13.6	9.3
	12			9.7	4.2	13.8	9.1	17.8	12.2	14.8	10.2
AVP-63SR	8	18.2	12.4	25.5	19.8	32.8	27.0	40.1	34.3	16.7	10.9
	9	16.8	10.4	24.1	17.7	31.4	24.9	38.7	32.2	18.8	12.3
	10	14.0	8.2	22.8	15.6	30.0	22.8	37.3	44.7	20.9	13.7
	11			21.5	13.5	28.7	20.7	36.0	28.0	22.9	15.0
	12			20.0	11.4	27.3	18.6	34.6	25.9	25.0	16.4
AVP-075SR	8	23.1	16.9	33.3	27.0	43.2	37.0	53.3	47.0	23.2	16.9
	9	21.0	14.1	31.2	24.1	41.1	34.1	51.2	44.2	26.1	19.0
	10	19.0	11.1	28.8	21.2	39.0	31.2	49.1	41.2	29.0	21.1
	11			27.0	18.3	37.0	28.3	47.0	38.4	31.9	23.2
	12			24.9	15.4	34.9	25.4	44.9	35.4	34.7	25.3
AVP-083SR	8	37.4	25.8	53.1	41.5	68.8	57.2	84.5	72.9	36.8	25.3
	9	34.2	21.3	49.9	37.0	65.6	52.6	81.2	68.3	41.4	28.5
	10	31.0	16.6	46.7	32.3	62.4	48.0	78.1	63.7	46.0	31.6
	11			43.6	27.7	59.3	43.4	75.0	59.1	50.6	34.8
	12			40.4	23.2	56.1	38.9	71.7	54.5	55.2	38.0
AVP-92SR	8	52.9	35.2	75.5	57.9	98.1	80.5	120.7	103	55.0	37.3
	9	48.2	28.4	70.9	51.0	93.5	73.6	116.0	96.1	61.9	42.0
	10	43.6	21.5	66.2	44.1	88.8	66.7	111.3	89.2	68.7	46.7
	11			61.5	37.2	84.1	59.9	106.6	82.4	75.6	51.4
	12			56.8	3.04	79.4	53.0	101.9	75.5	82.5	56.0
AVP-105SR	8	81.6	53.5	114.7	86.5	147.7	119.6	180.8	152.7	78.7	50.6
	9	75.3	43.7	108.4	76.8	141.5	109.8	174.5	142.9	88.6	56.9
	10	68.9	33.4	102.0	66.5	135.1	99.6	168.2	132.6	98.4	63.3
	11			95.7	57.0	128.7	90.1	161.8	123.1	108.3	69.6
	12			89.4	47.5	122.5	80.6	155.5	113.6	118.1	75.9
AVP-125SR	8	117	75	167	125	217	176	268	226	125	84
	9	107	59	157	109	207	159	257	210	141	94
	10	96	44	146	94	196	144	247	194	157	105
	11			136	78	186	126	236	178	173	115
	12			125	63	176	113	226	163	188	115



Torque Output - Single Acting



Highlights best balance between air and spring strokes

Air Supply Pressure		4 Bar		5 Bar		6 Bar		7Bar		Spring Torque	
AVP Model	No of springs	0°	90°	0°	90°	0°	90°	0°	90°	90°	0°
		Air Start	Air End Nm	Air Start Nm	Air End Nm	Air Start Nm	Air End Nm	Air Start Nm	Air End Nm	Spring Start	Spring End Nm
AVP-140SR	8	205	136	291	221	376	307	462	392	206	137
	9	187	110	273	196	358	281	444	367	232	155
	10	170	84	256	169	341	255	427	340	258	172
	11			238	143	324	229	109	314	284	189
	12			221	118	307	203	392	289	310	206
AVP-160SR	8	309	199	442	290	575	465	708	598	333	223
	9	290	157	413	237	546	423	679	556	375	251
	10	253	115	386	248	519	381	652	514	417	276
	11			358	207	491	340	624	473	485	307
	12			330	165	463	298	596	431	500	335
AVP-190SR	8	531	356	744	569	957	782	1169	995	495	320
	9	491	295	704	507	917	720	1130	933	557	360
	10	451	233	664	446	877	658	1090	871	618	400
	11			624	384	837	597	1050	809	680	440
	12			584	322	797	535	1010	748	742	480
AVP-210SR	8	624	456	890	722	1156	988	1422	1254	608	440
	9	569	380	835	464	1101	912	1367	1178	684	495
	10	514	304	780	570	1046	836	1312	1102	760	550
	11			725	494	991	760	1257	1026	836	605
	12			670	418	936	684	1202	950	912	660
AVP-240SR	8	883	653	1267	1037	1652	1422	2037	1807	886	656
	9	800	542	1185	926	1569	1311	1954	1696	998	739
	10	718	431	1103	816	1488	1201	1872	1586	1108	821
	11			1021	705	1406	1090	1791	1474	1219	903
	12			939	594	1323	979	1708	1363	1330	985
AVP-270SR	8	1444	1081	2029	1666	2614	2252	3199	2836	1258	895
	9	1332	923	1917	1509	2502	2094	3087	2678	1416	1007
	10	1220	767	1805	1352	2390	1937	2974	2521	1572	1119
	11			1693	1194	2278	1779	2862	2364	1730	1231
	12			1582	1037	2167	1623	2751	2207	1887	1342
AVP-300SR	8	1754	1166	2517	1929					1697	1168
	9	1592	930	2355	1693	3118	2456			1909	1213
	10	1430	695	2193	1458	2956	2221	3719	2984	2122	1460
	11			2030	1222	2793	1985	3556	2748	2334	1606
	12			1868	986	2631	1749	3394	2512	2546	1750



Torque Output - Single Acting



Highlights best balance between air and spring strokes

Air Supply Pressure		4 Bar		5 Bar		6 Bar		7Bar		Spring Torque	
AVP Model	No of springs	0°	90°	0°	90°	0°	90°	0°	90°	90°	0°
		Air Start Nm	Air End Nm	Air Start Nm	Air End Nm	Air Start Nm	Air End Nm	Air Start Nm	Air End Nm	Spring Start Nm	Spring End Nm
AVP-350SR	8	2484	1544	3626	2686					2724	1877
	9	2224	1165	3366	2307	4508	3449			3064	2112
	10	1936	787	3105	1929	4247	3071	5390	4214	3405	2346
	11			2804	1551	3986	2693	5129	3836	3745	2581
	12			2584	1172	3726	2314	4869	3457	4086	2816
AVP-400SR	8										
	9	3887	2396							3703	2362
	10	3595	1939	5223	3567					4115	2624
	11	3303	1482	4931	3110	6559	4738			4526	2887
	12	3012	1025	4640	2653	6268	4281	7895	5908	4938	3149
	13			4348	2195	5976	3823	7603	5450	5349	3412
	14			4057	1738	5685	3866	7312	4993	5761	3674
	15			3765	1281	5393	2909	7020	4536	6172	3937
16					5101	2452	6728	4079	6584	4199	

Double acting or spring return in the same housing:

AVP Pneumatic actuators use the same housing for both double acting and spring return functions. The end caps have moulded sockets that match similar sockets in the piston crown to securely hold the pre-loaded spring cartridges used in the spring return version.

Accessories Available for AVP actuators

AVP pneumatic actuators are supplied with a local visual position indicator. For position monitoring, feedback and control, separate devices can quickly and easily be mounted to the AVP actuator using the Namur interfaces provided. The most common are:

Namur solenoid valves directly mount to the Namur interface and with compressed air continuously applied to the solenoid, and provide electrical control of the pneumatic actuator. They are available in a range of body materials, coil voltages and can be supplied to cover either safe or hazardous area applications.

Limit Switch Boxes directly mount to the VDI/VDE3845 interface and offer local visual and electrical remote feedback of the AVP pneumatic actuator's position, commonly to confirm final open and closed positions. They are available in a range of body materials, switch types and can be supplied to cover either safe or hazardous area applications.

Positioners directly mount to the VDI interface and provide proportional or modulating control. With compressed air continuously applied to the positioner, it converts a 4-20mA output signal from a process controller into a 3-15psi pneumatic signal which it then uses to control the movement of the actuator proportionally to the signal.

Positioners are available in a range of body materials, functional designs (basic to digital), can be used with various communication protocols (eg: Fieldbus, HART) and can be supplied to cover either safe or hazardous area applications.

